

Competition grounds en B-section Breda 2016

Start B-section

- | | |
|---------|---------|
| Obst. 1 | Km 5 |
| Km 1 | Obst. 5 |
| Obst. 2 | Km 6 |
| Km 2 | Gate 5 |
| Gate 1 | Obst. 6 |
| Gate 2 | Km 7 |
| Obst. 3 | Gate 6 |
| Km 3 | Gate 7 |
| Gate 3 | Obst. 7 |
| Obst. 4 | Km 8 |
| Km 4 | Gate 8 |
| Gate 4 | Obst. 8 |

Finish B-section: 9000 m

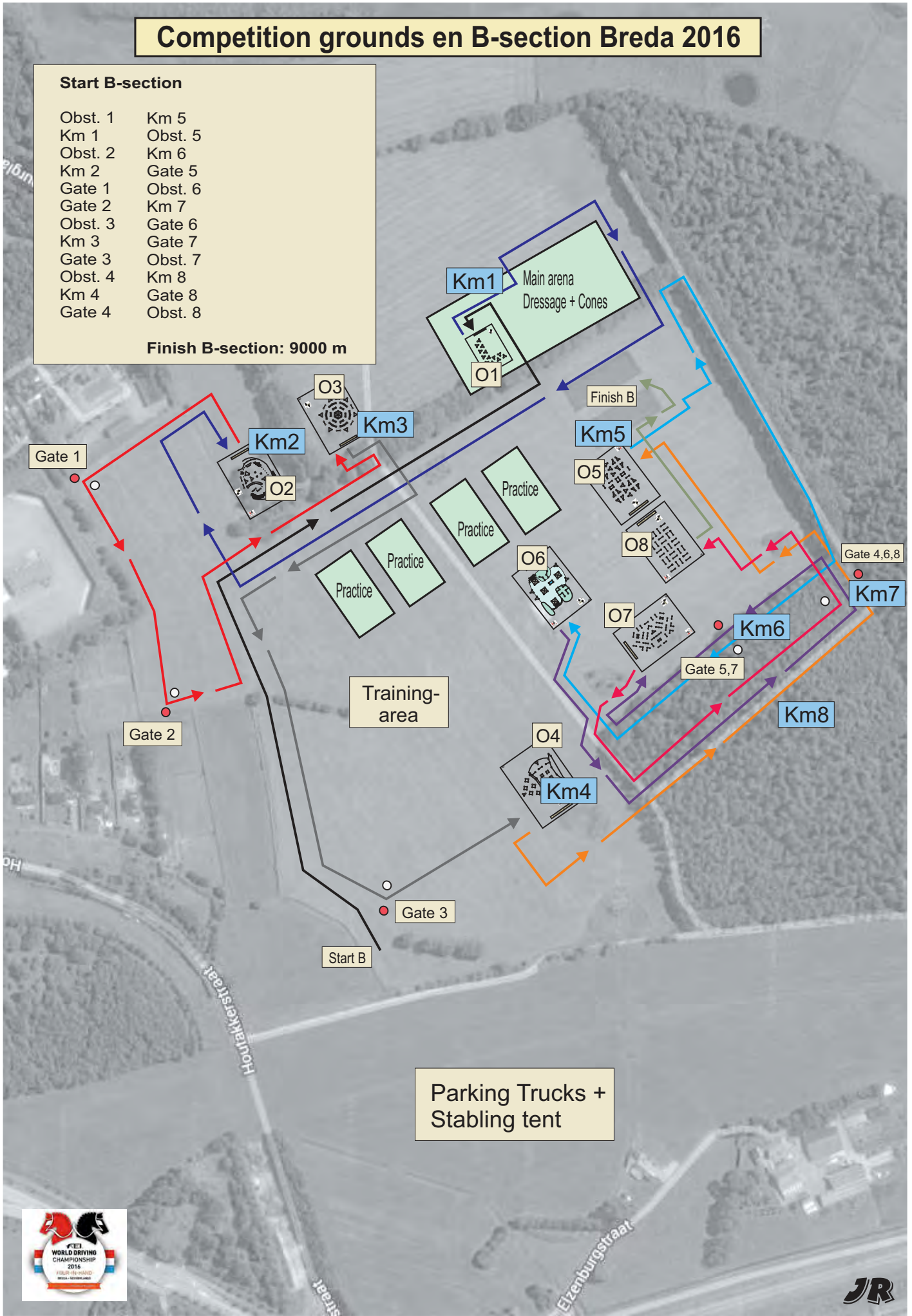

Hindernis / Obstacle 1.

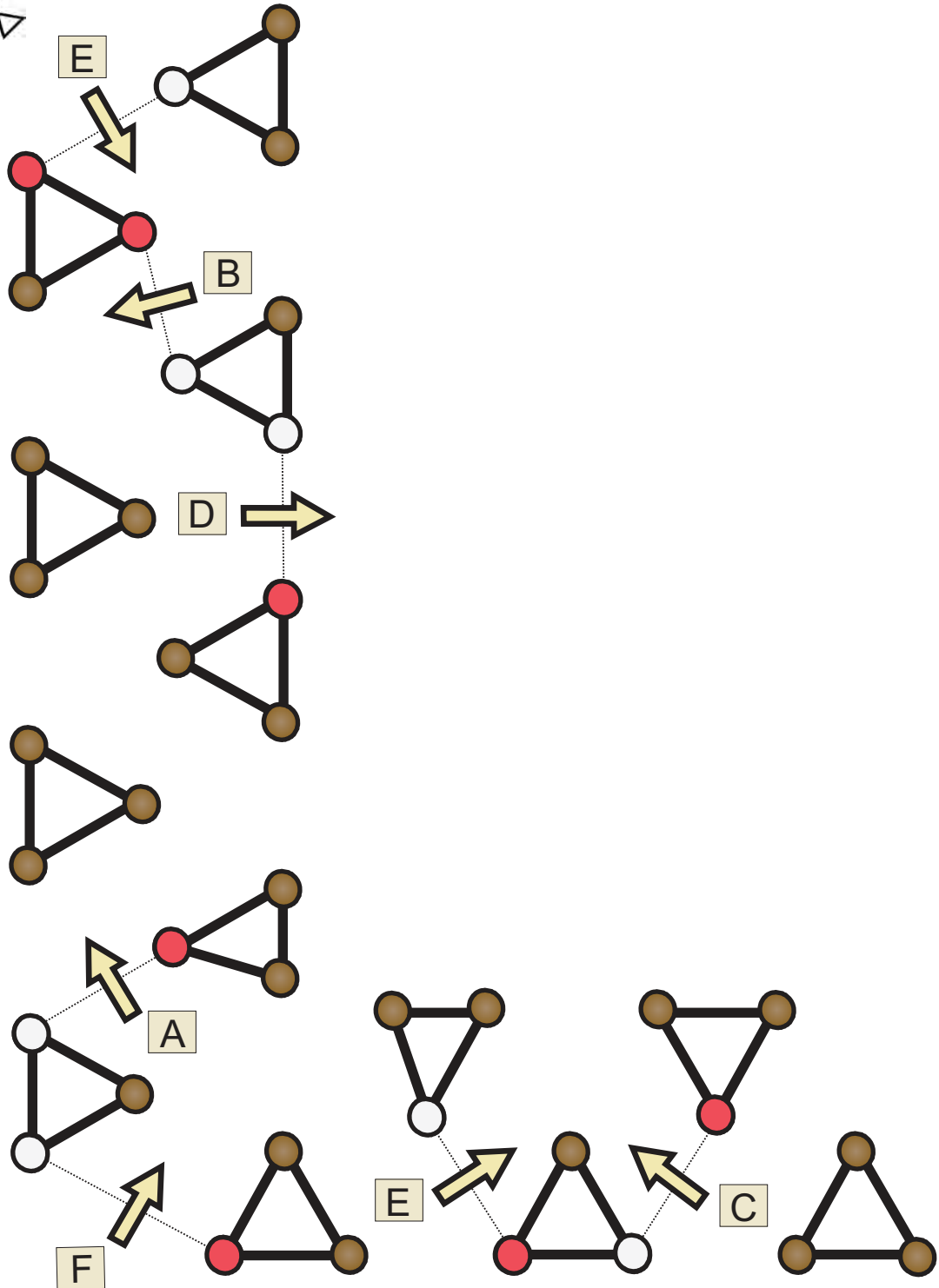
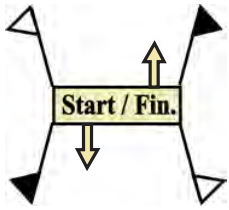

Hindernis / Obstacle 2.

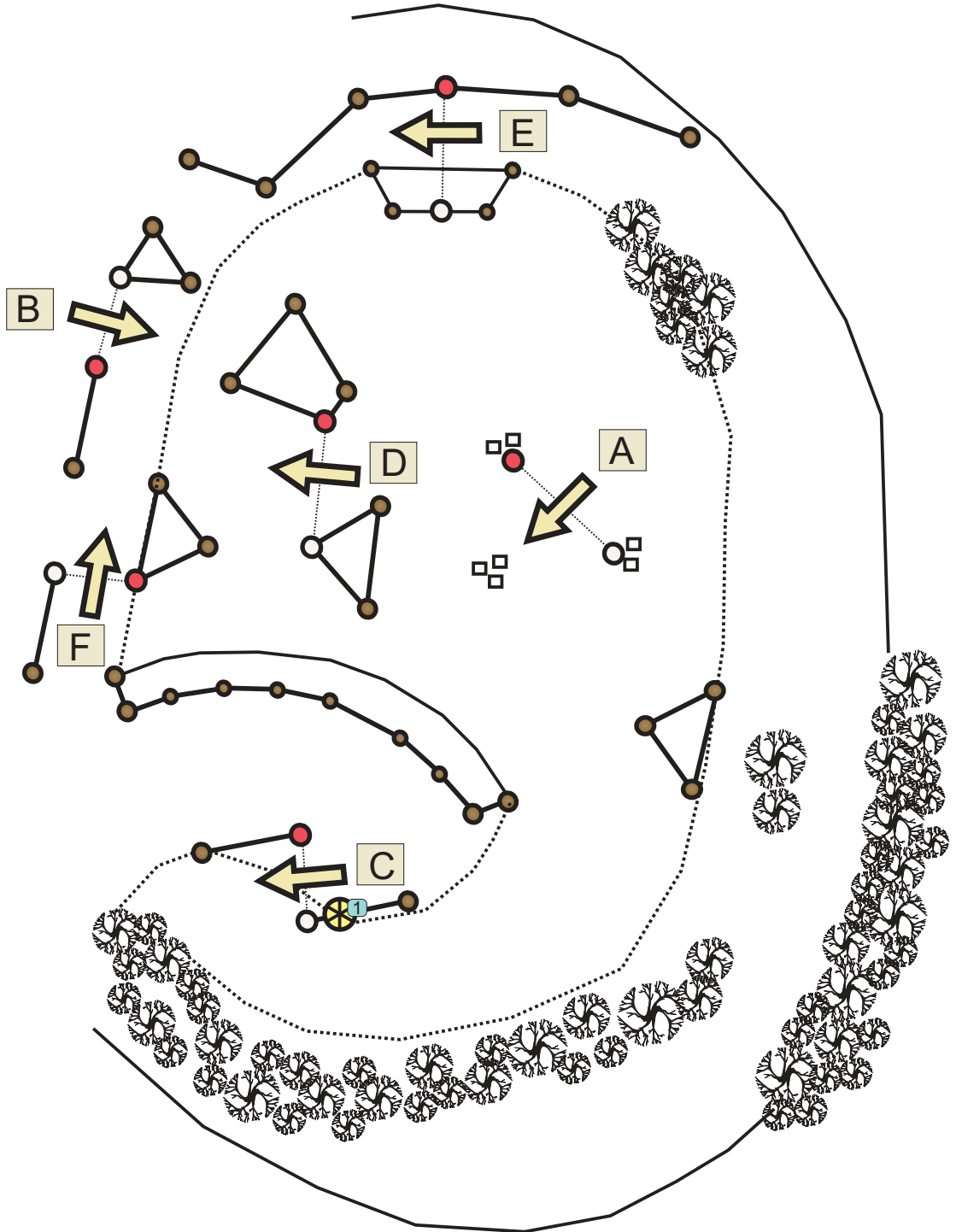

 = Knock down (1x)



Hindernis / Obstacle 3.

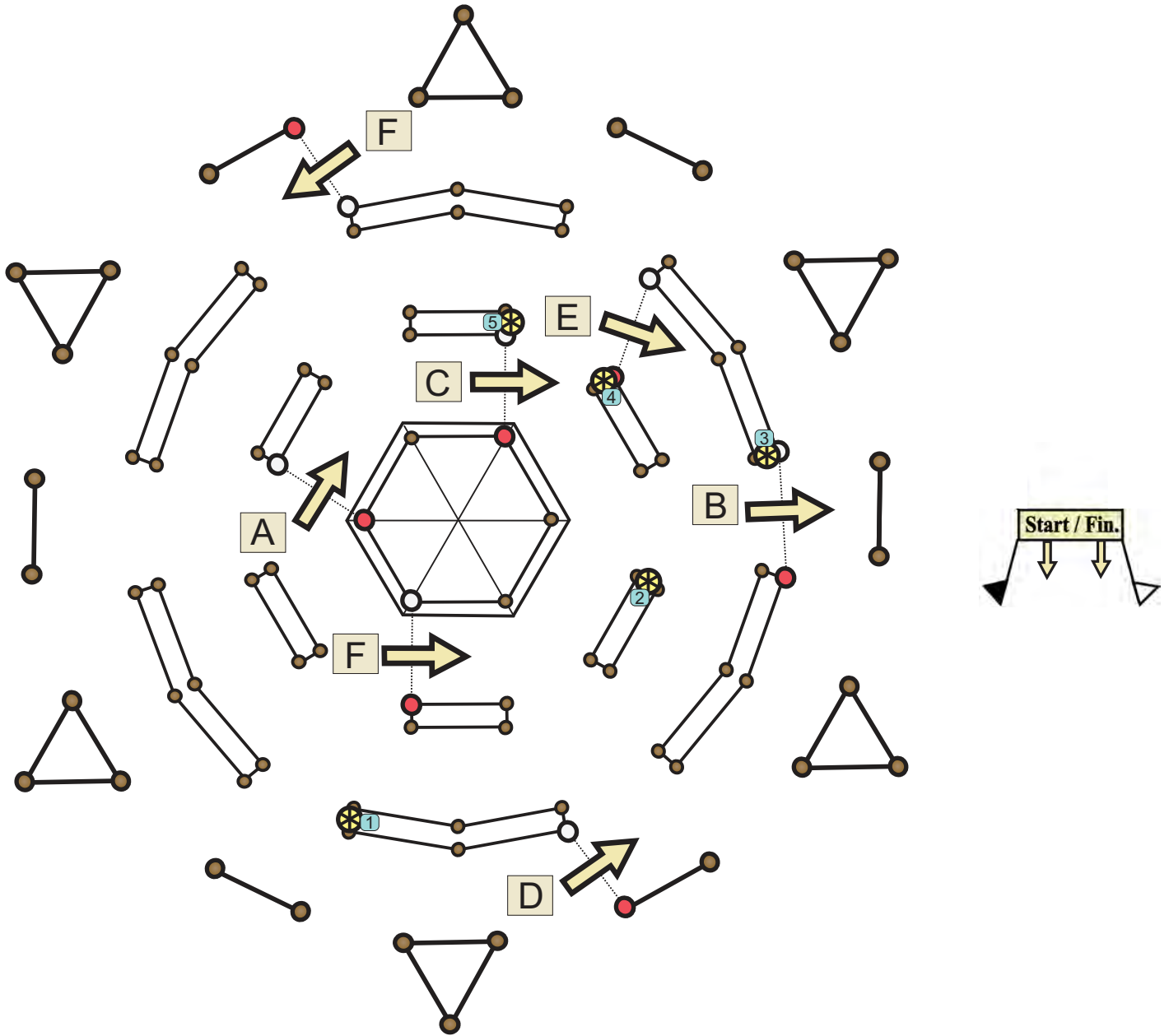

☼ = Knock down (5x)



Hindernis / Obstacle 4.

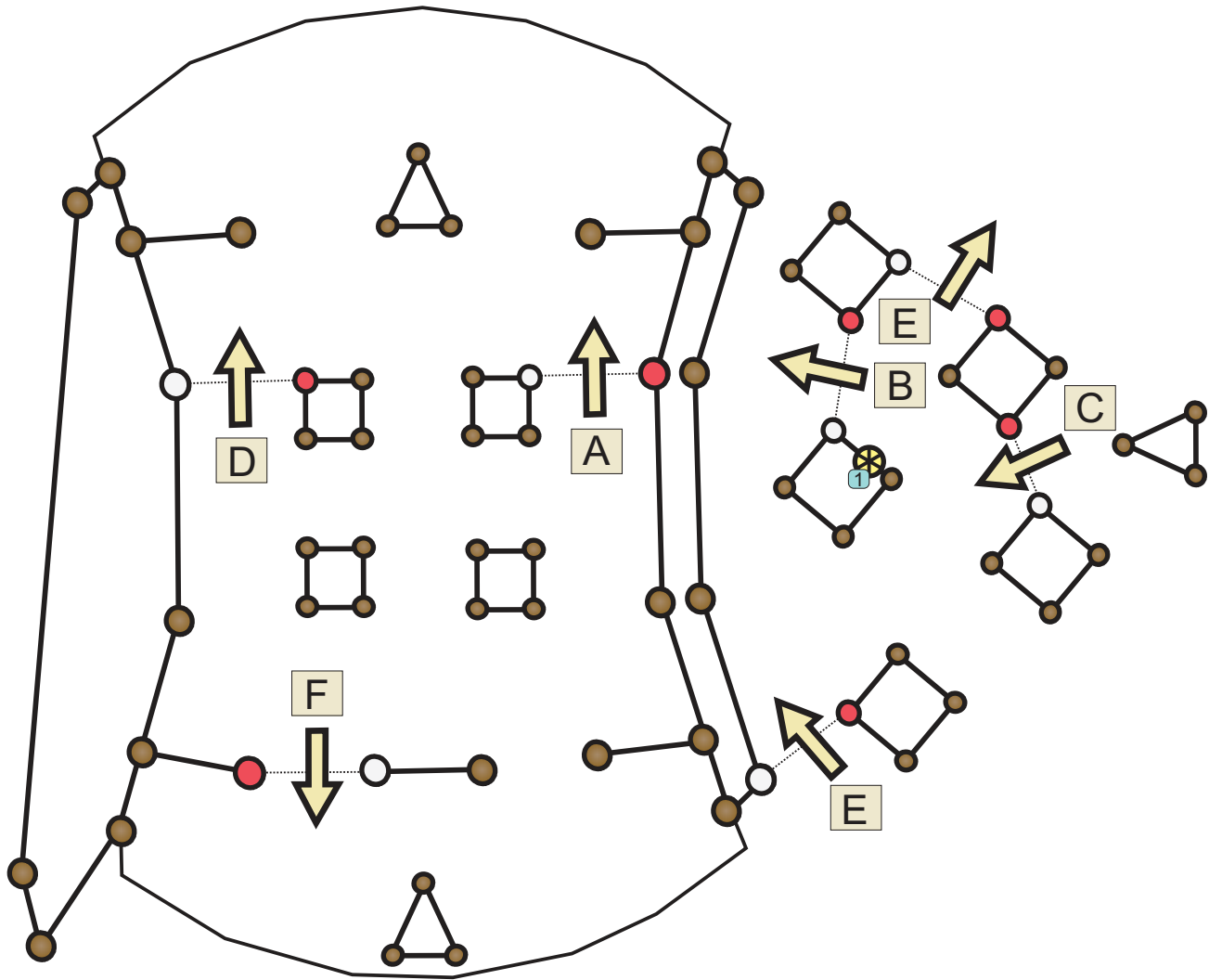
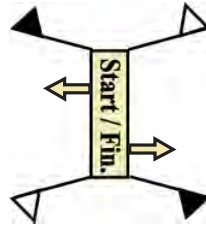

⊗ = Knock down (1x)



Hindernis / Obstacle 5.

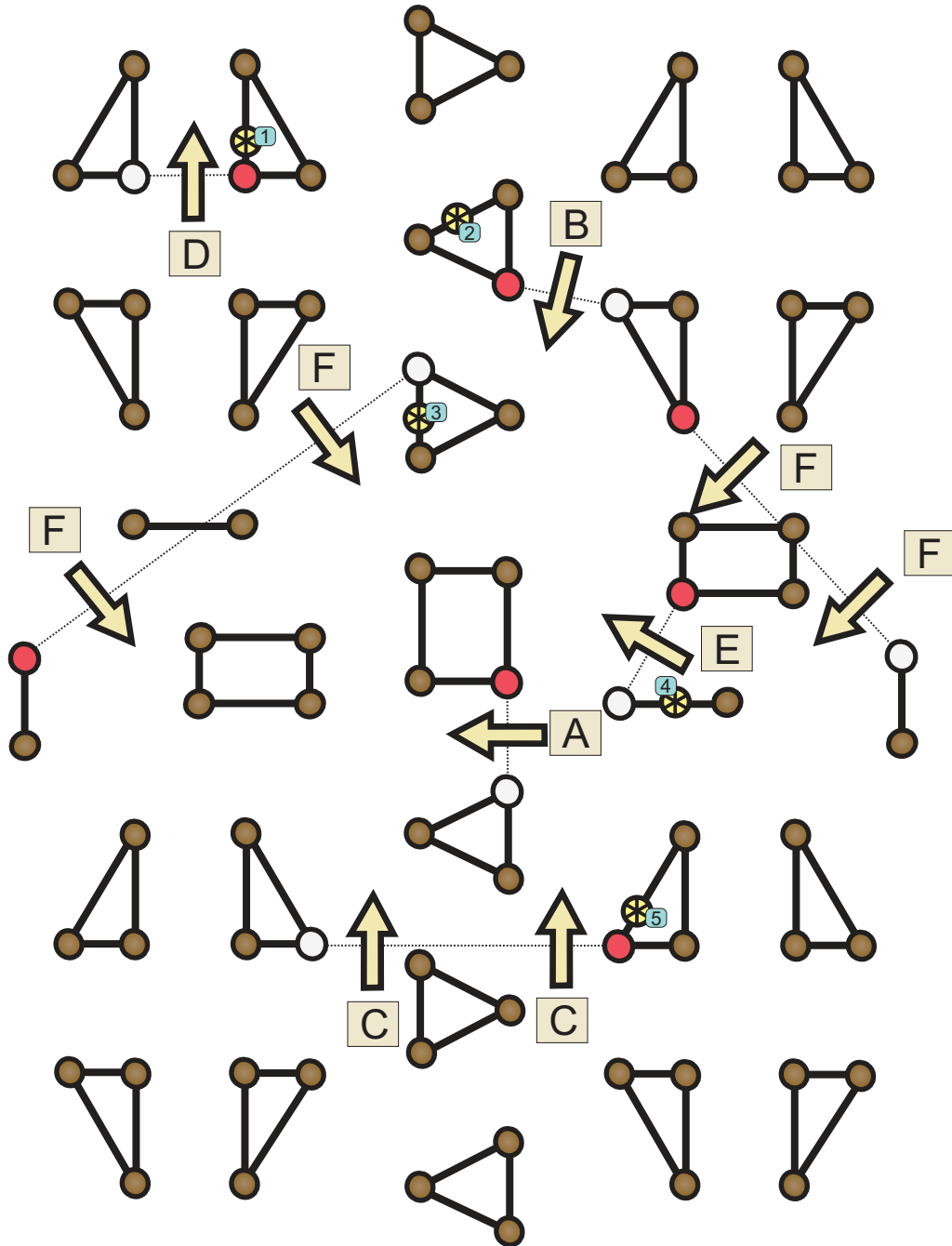
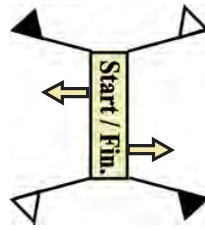

= Knock down (5x)



Hindernis / Obstacle 6.

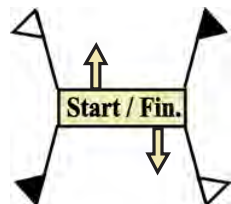
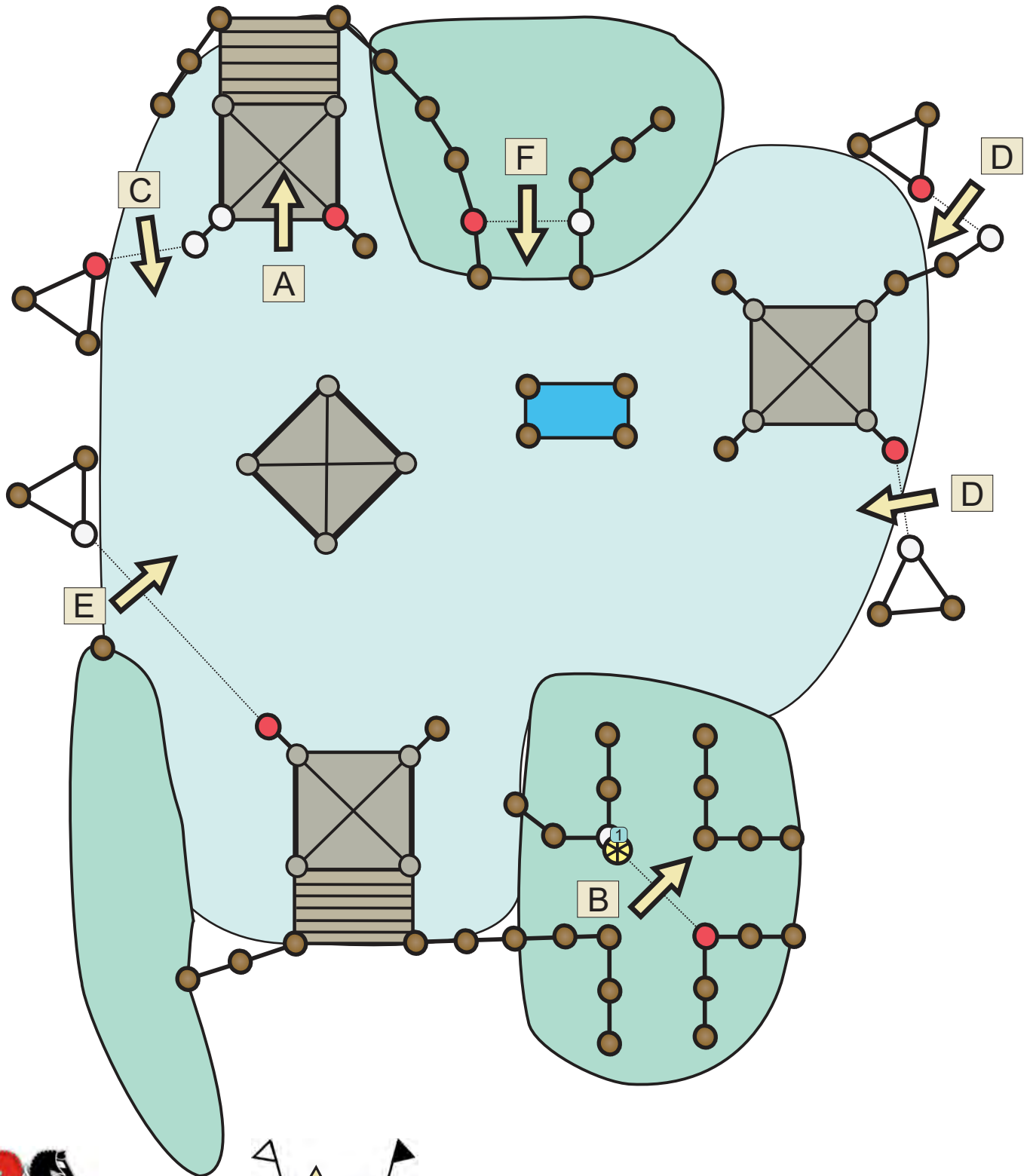

⊗ = Knock down (1x)



Hindernis / Obstacle 7.

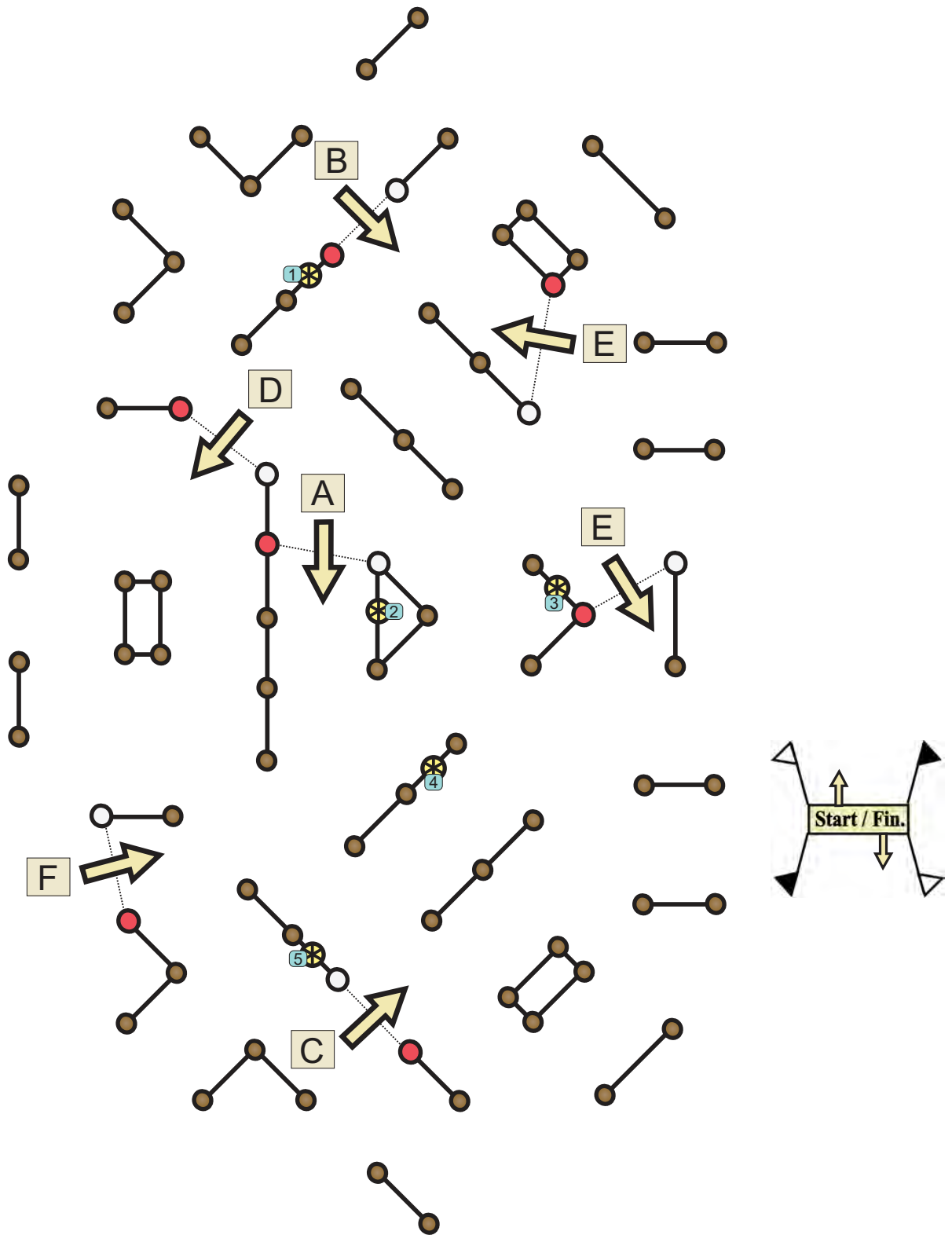

⊗ = Knock down (5x)



Hindernis / Obstacle 8

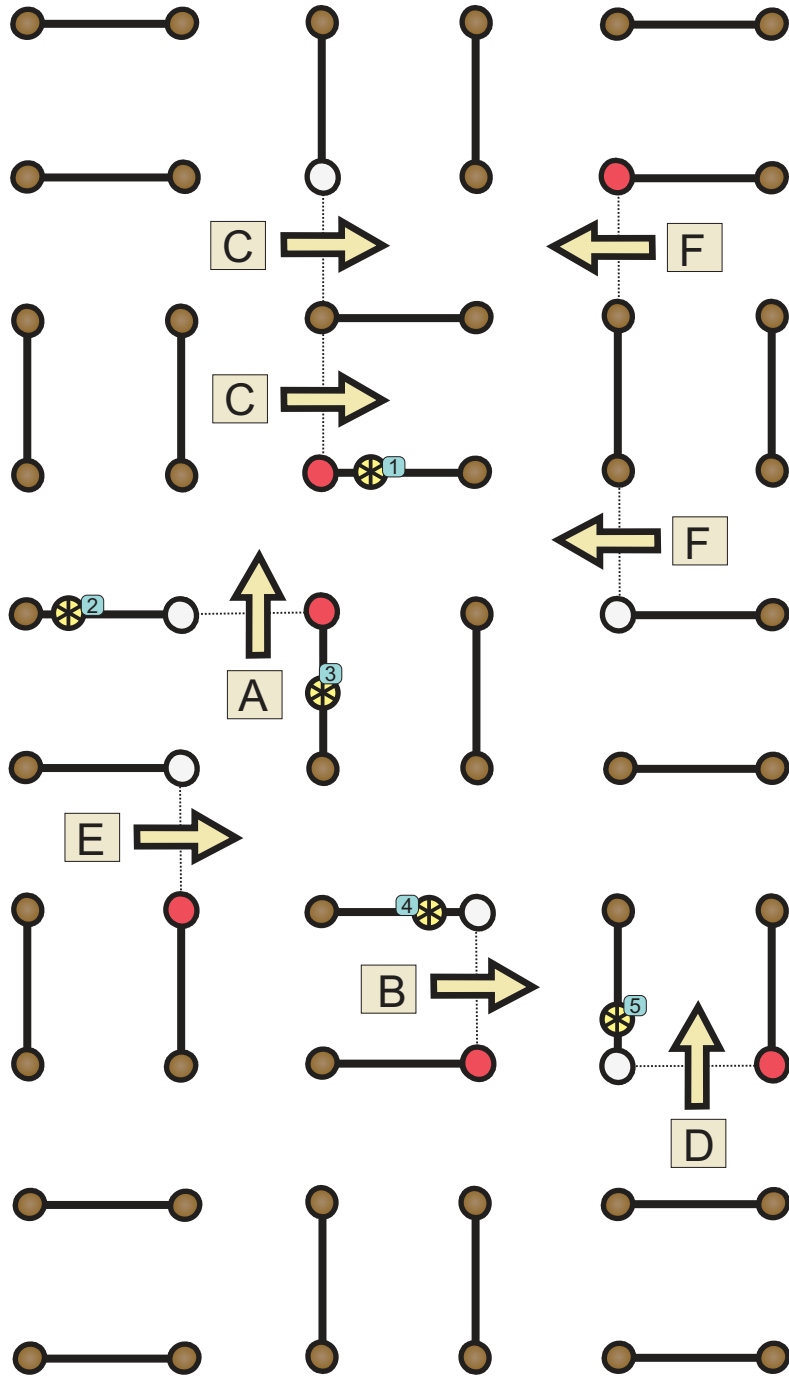

⊗ = Knock down (5x)



Sections Marathon Outdoor Brabant Breda 2016

Competition grounds +
B-Section

A-section	: 6100 m
Neutral zone	: 150 m
Transferzone	: 1000 m
Rest + Neutral zone	: 400 m
B-section	: 9000 m

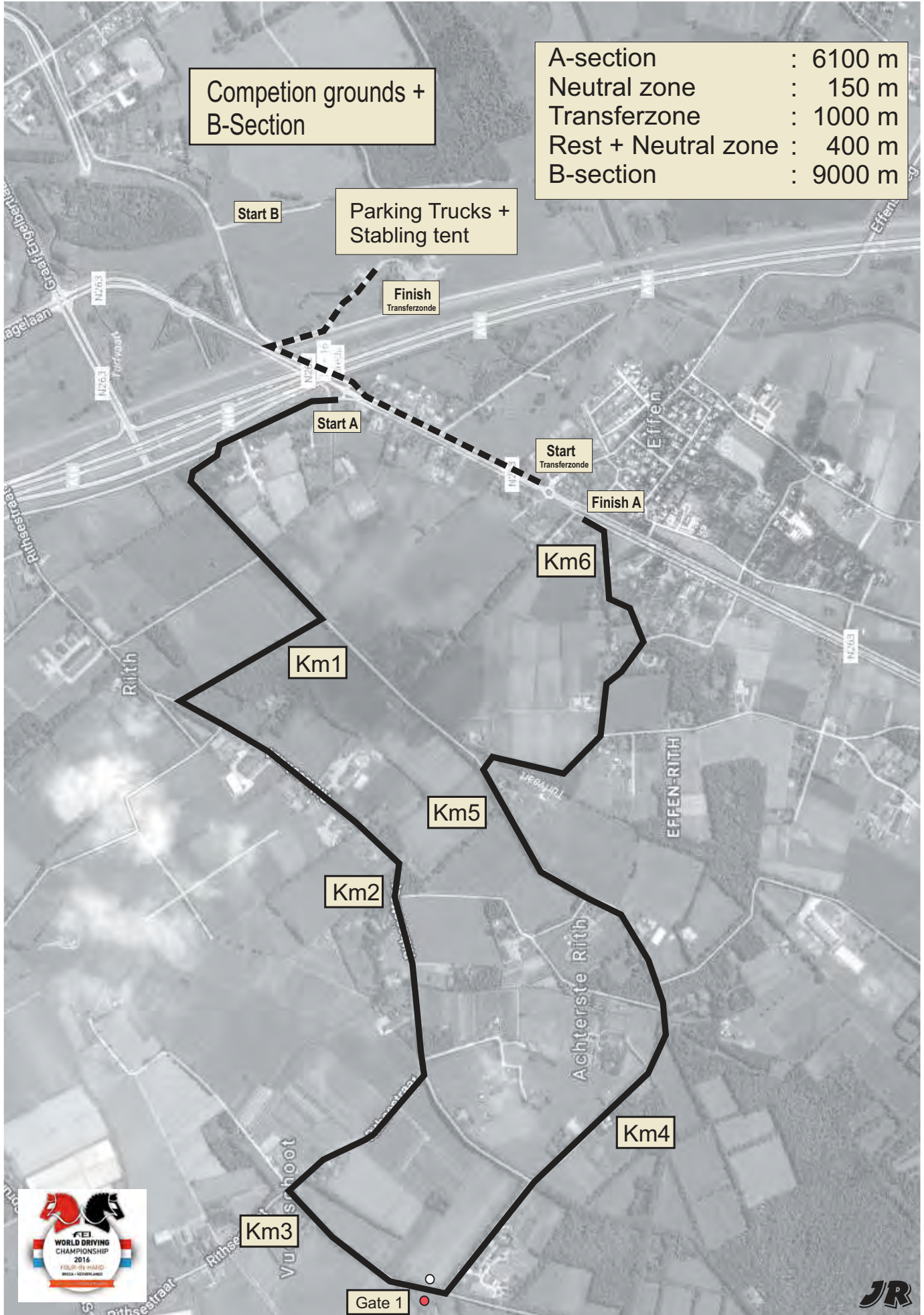

Outdoor Brabant - Breda 2016

Horses

	Distance in meters	Speed in km/u	Minimum time	Time allowed	Maximum time	Gates
A-Section	6.100	15	0:22:24	0:24:24	0:29:17	1
Neutral zone 1	150			0:03:00		
Transferzone	1.000	5		0:12:00	0:24:00	
Rest				0:10:00		
Neutral zone 2	400			0:05:00		
B -Section	9.000	14	0:35:35	0:38:35	1:17:10	8
Total	16.650			1:32:59		9