

Pusztatemplom

# CAIO 4-CAI 2\* FÁBIÁNSEBESTYÉN 2017 Maraton competition Section A -Transfer



**Timetable Marathon**
**Time Table 1 PONY SINGLE 2\* Obstacles 1234678**

Section	Distance in m	Speed in km/h	Minimum Time	Allowed Time	MaximumTime
A	6 000	14,00	<b>23:43</b>	<b>25:43</b>	30:52
T	1 000	7,00		<b>08:35</b>	10:18
B	8 570	13,00	<b>36:34</b>	<b>39:34</b>	01:19:08

**Time Table 2 HORSE SINGLE 2\* Obstacles 1234678**

Section	Distance in m	Speed in km/h	Minimum Time	Allowed Time	MaximumTime
A	6 000	15,00	<b>22:00</b>	<b>24:00</b>	28:48
T	1 000	7,00		<b>08:35</b>	10:18
B	8 570	14,00	<b>33:44</b>	<b>36:44</b>	01:13:28

**Time Table 3 PONY PAIR 2\* Obstacles 1234678**

Section	Distance in m	Speed in km/h	Minimum Time	Allowed Time	MaximumTime
A	6 000	14,00	<b>23:43</b>	<b>25:43</b>	30:52
T	1 000	7,00		<b>08:35</b>	10:18
B	8 570	13,00	<b>36:34</b>	<b>39:34</b>	01:19:08

**Time Table 4 HORSE PAIR 2\* Obstacles 1234678**

Section	Distance in m	Speed in km/h	Minimum Time	Allowed Time	MaximumTime
A	6 000	15,00	<b>22:00</b>	<b>24:00</b>	28:48
T	1 000	7,00		<b>08:35</b>	10:18
B	8 570	14,00	<b>33:44</b>	<b>36:44</b>	01:13:28

**Time Table 5 PONY FOUR-IN-HAND 2\* Obstacles 1234678**

Section	Distance in m	Speed in km/h	Minimum Time	Allowed Time	MaximumTime
A	6 000	14,00	<b>23:43</b>	<b>25:43</b>	30:52
T	1 000	7,00		<b>08:35</b>	10:18
B	8 570	13,00	<b>36:34</b>	<b>39:34</b>	01:19:08

**Time Table 6 HORSE FOUR-IN-HAND 2\* Obstacles 1234678**

Section	Distance in m	Speed in km/h	Minimum Time	Allowed Time	MaximumTime
A	6 000	15,00	<b>22:00</b>	<b>24:00</b>	28:48
T	1 000	7,00		<b>08:35</b>	10:18
B	8 570	14,00	<b>33:44</b>	<b>36:44</b>	01:13:28

**Time Table 7 HORSE FOUR-IN-HAND 4\* Obstacles 12345678**

Section	Distance in m	Speed in km/h	Minimum Time	Allowed Time	MaximumTime
A	6 000	15,00	<b>22:00</b>	<b>24:00</b>	28:48
T	1 000	7,00		<b>08:35</b>	10:18
B	8 800	14,00	<b>34:43</b>	<b>37:43</b>	01:15:26

©Driving Program by Philippe Liénart (BEL) - philippe@lienart.com

Scorer : Horváth Dániel

CAIO 4\*

Maraton Section B

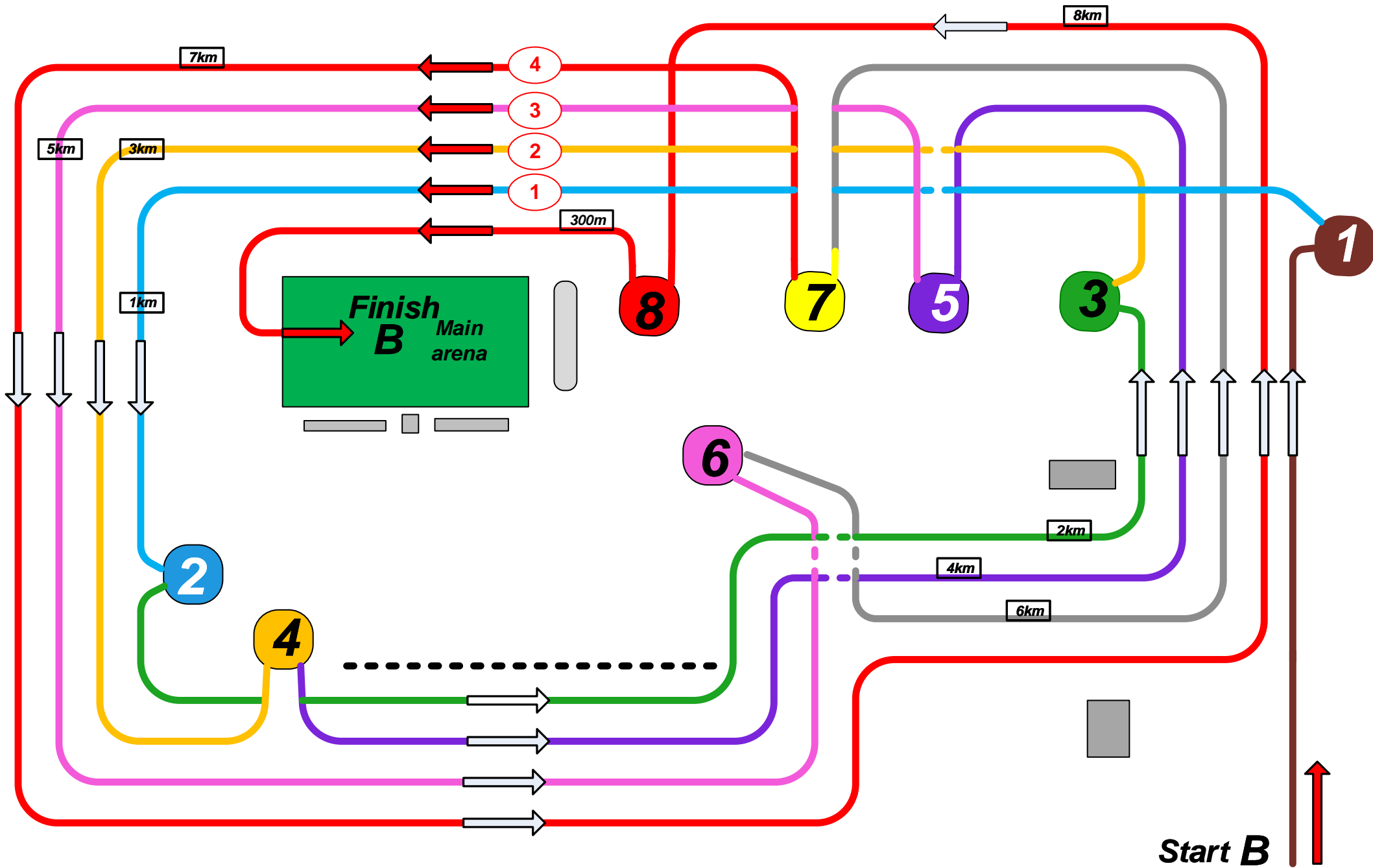

***Fábiánsebestyén 2017 CAIO 4 \****

***START B***

**Obstacle 1**

CTF 1

1 Km

**Obstacle 2**

2 Km

**Obstacle 3**

CTF 2

3 Km

**Obstacle 4**

4 Km

**Obstacle 5**

CTF 3

5 Km

**Obstacle 6**

6 Km

**Obstacle 7**

CTF 4

7 Km

8 Km

**Obstacle 8**

300 m

***FINISH B 8800 m***

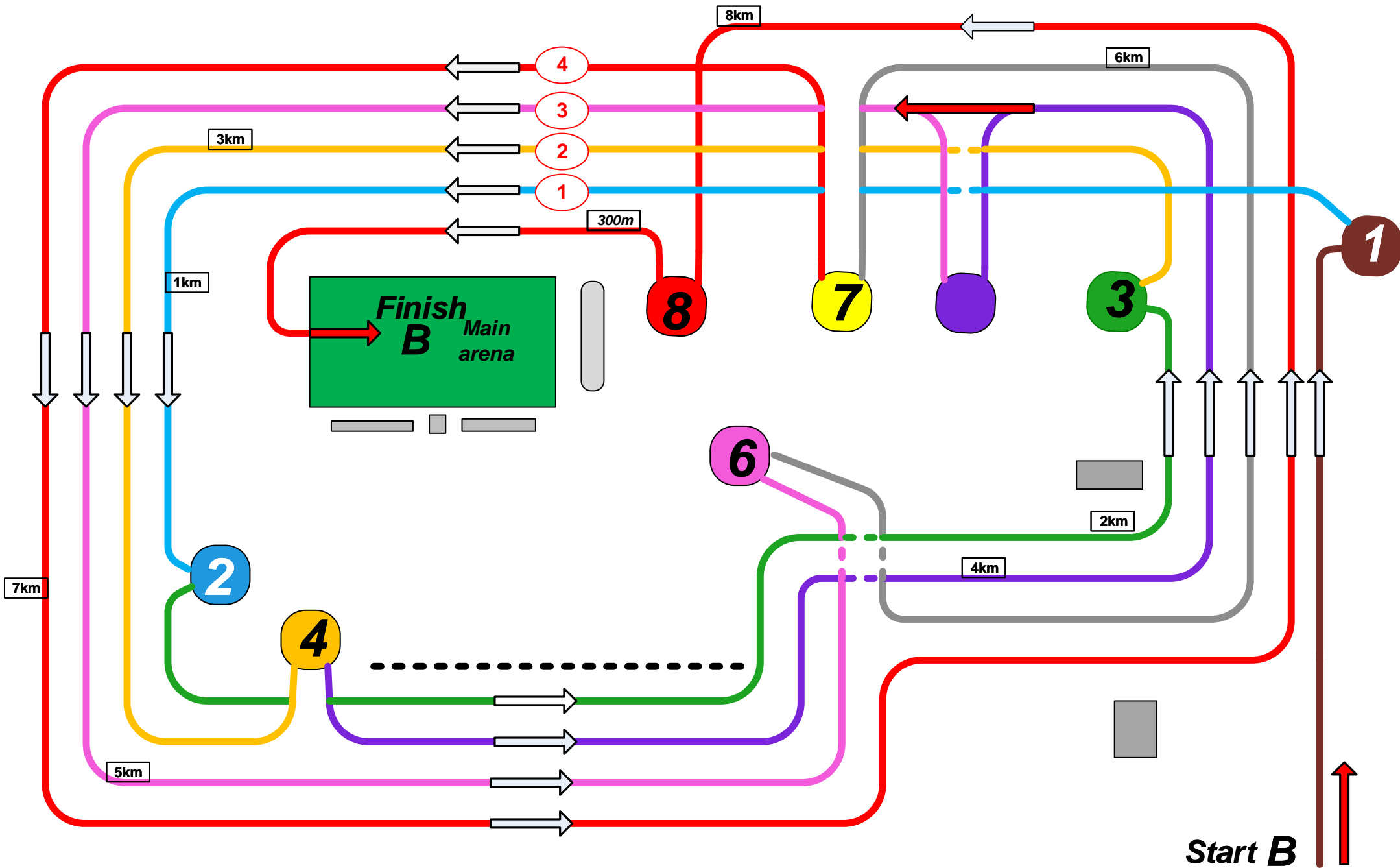

***Fábiánsebestyén 2017 CAI 2\****

***START B***

**Obstacle 1**

CTF 1

1 Km

**Obstacle 2**

2 Km

**Obstacle 3**

CTF 2

3 Km

**Obstacle 4**

4 Km

CTF 3

5 Km

**Obstacle 6**

6 Km

**Obstacle 7**

CTF 4

7 Km

8 Km

**Obstacle 8**

300 m

***FINISH B 8570m***

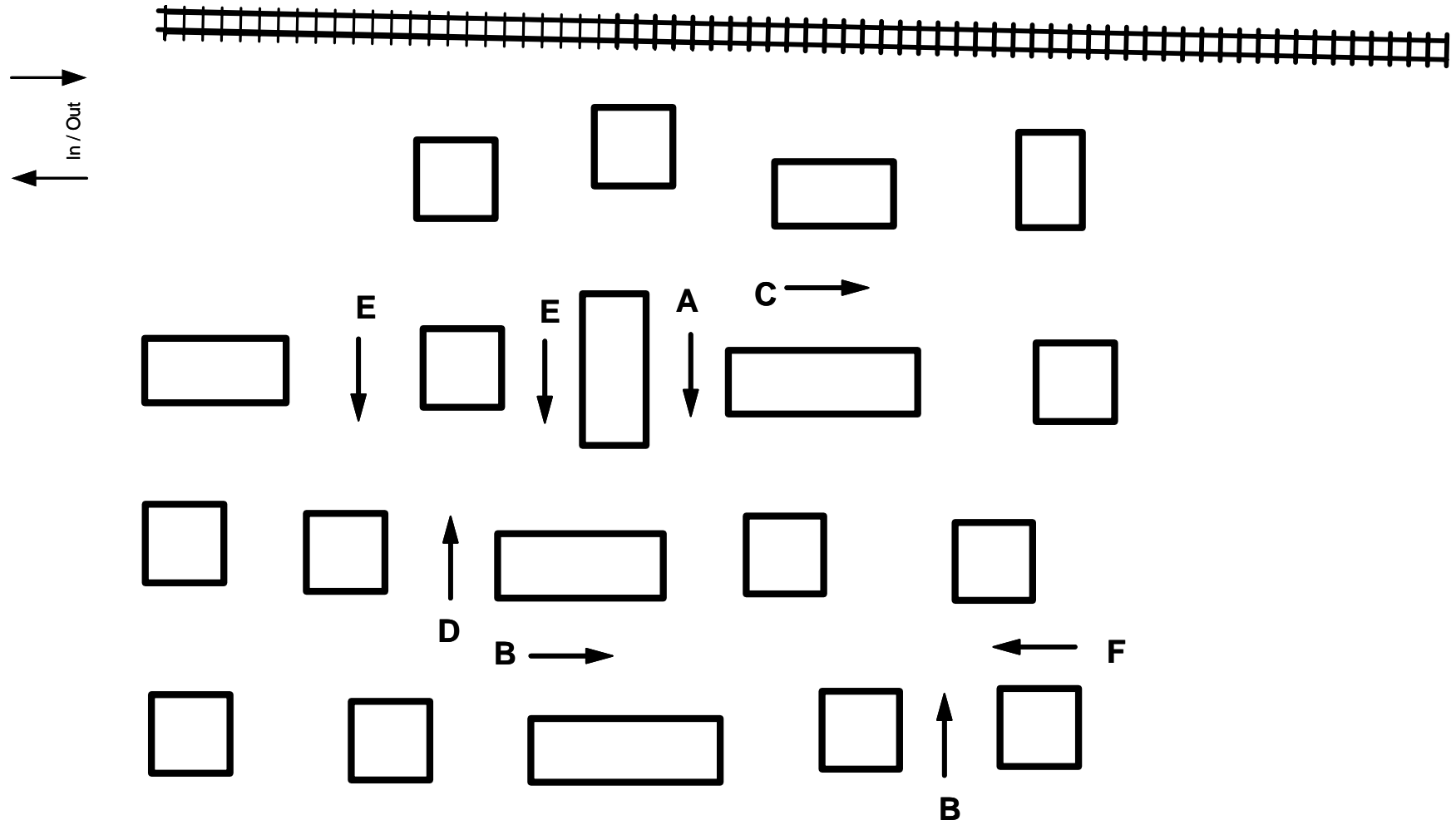

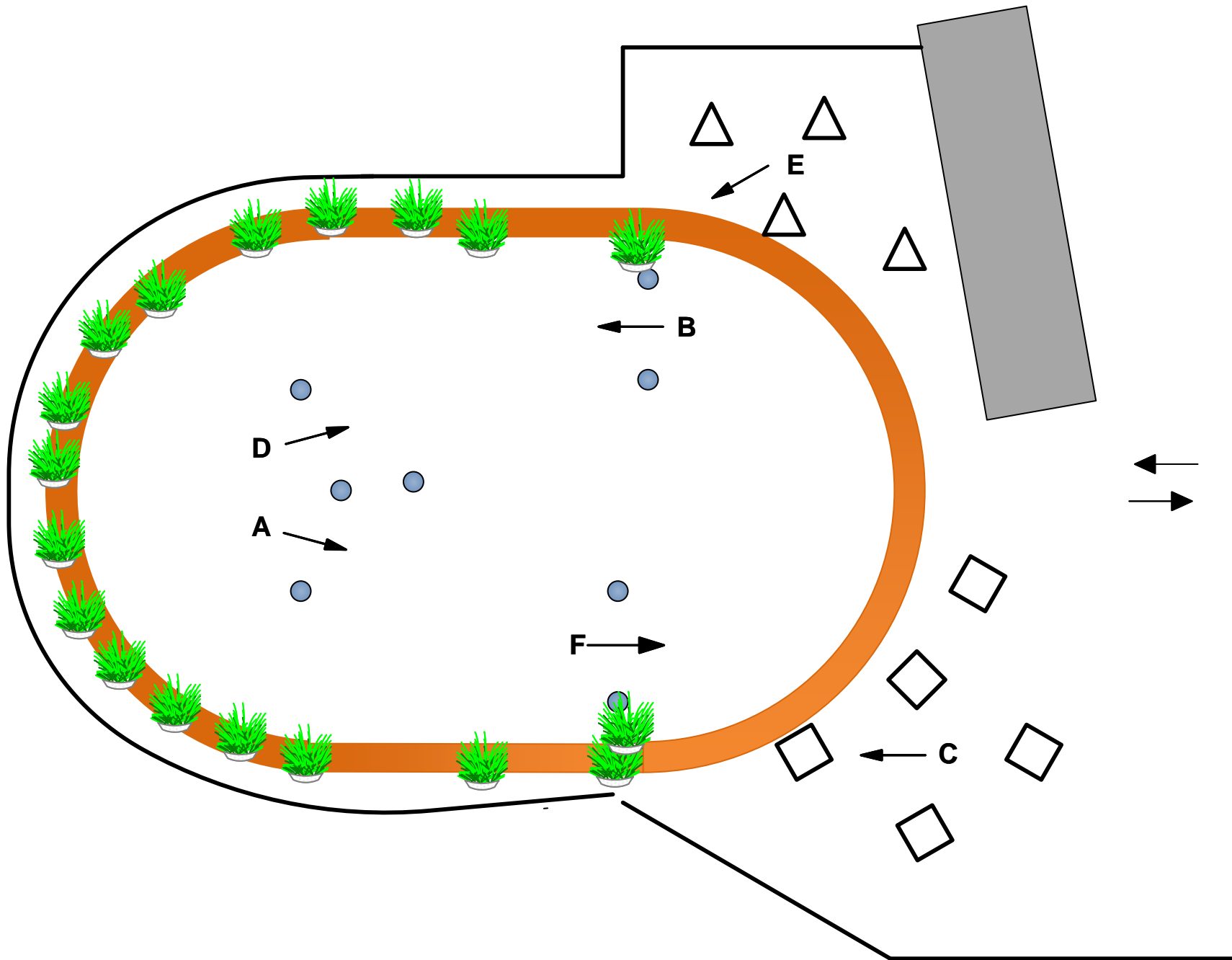



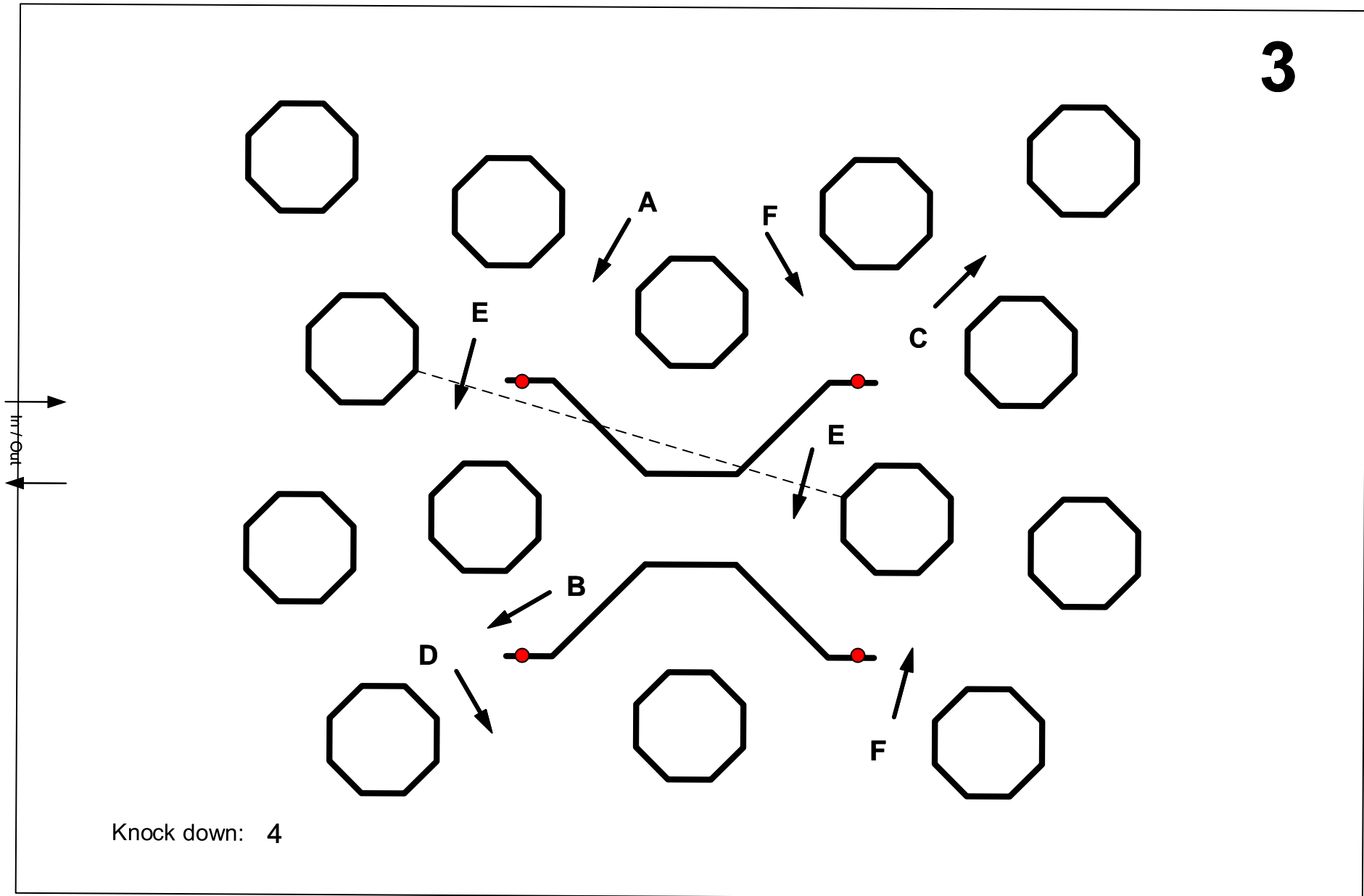

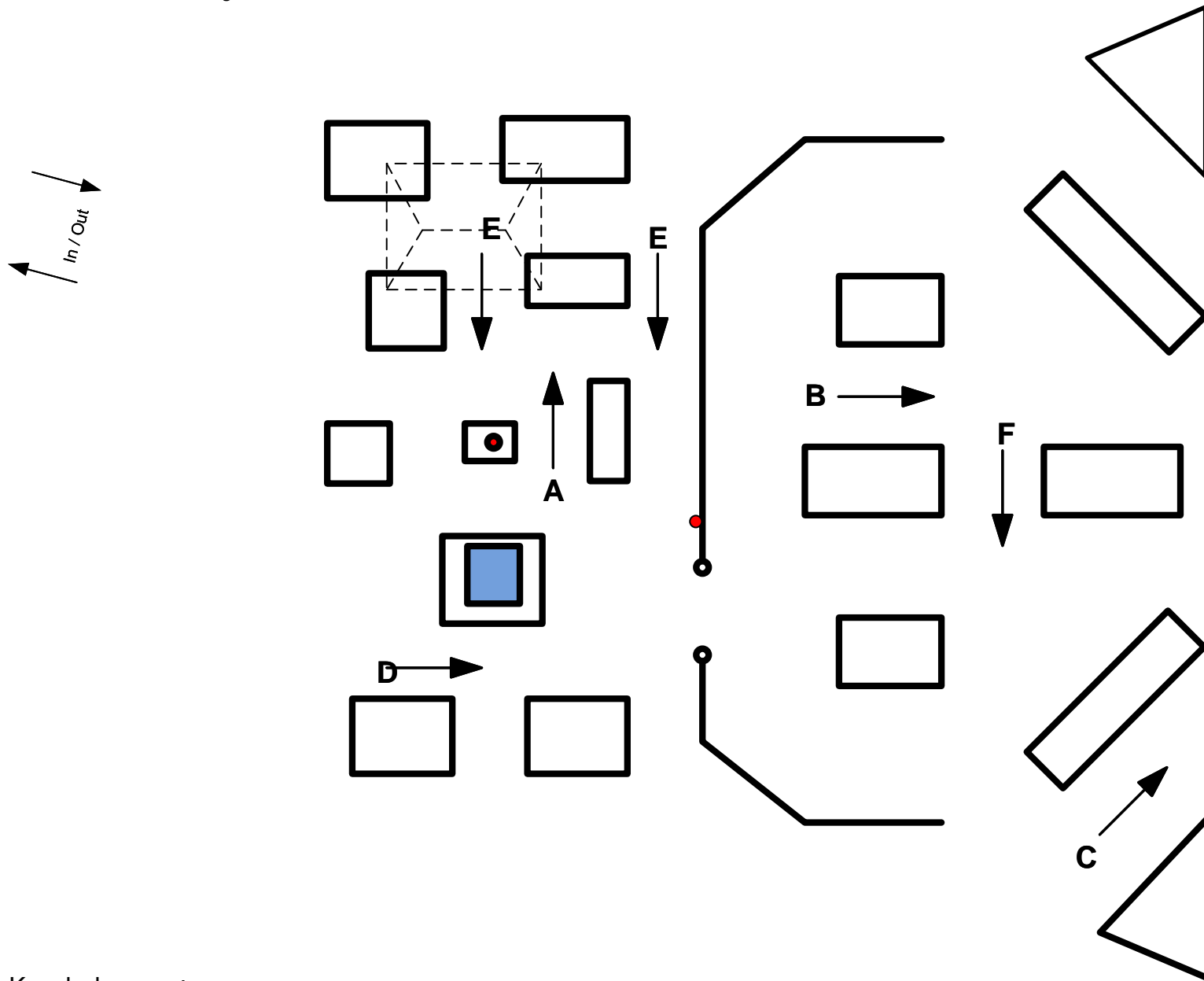

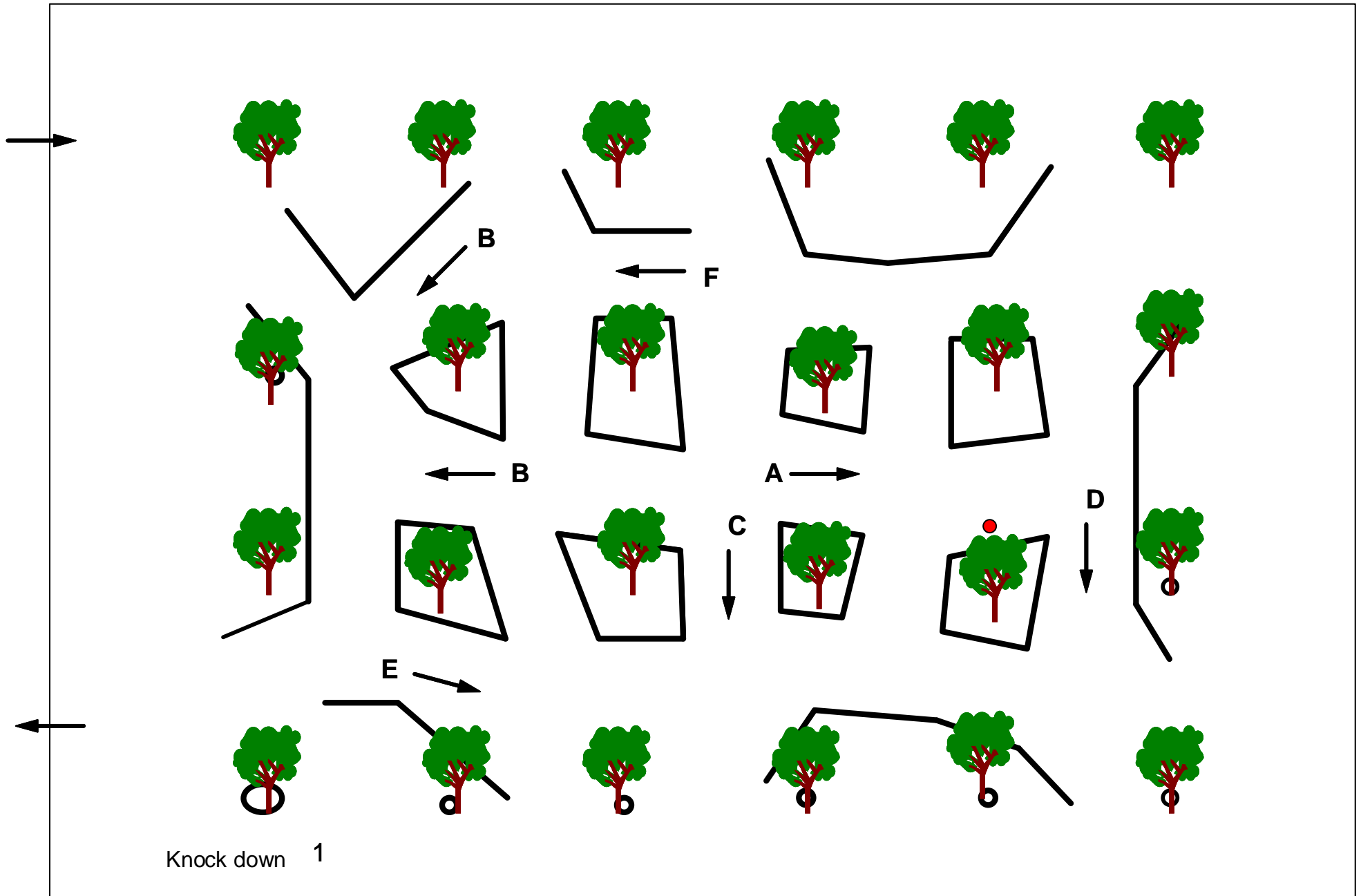

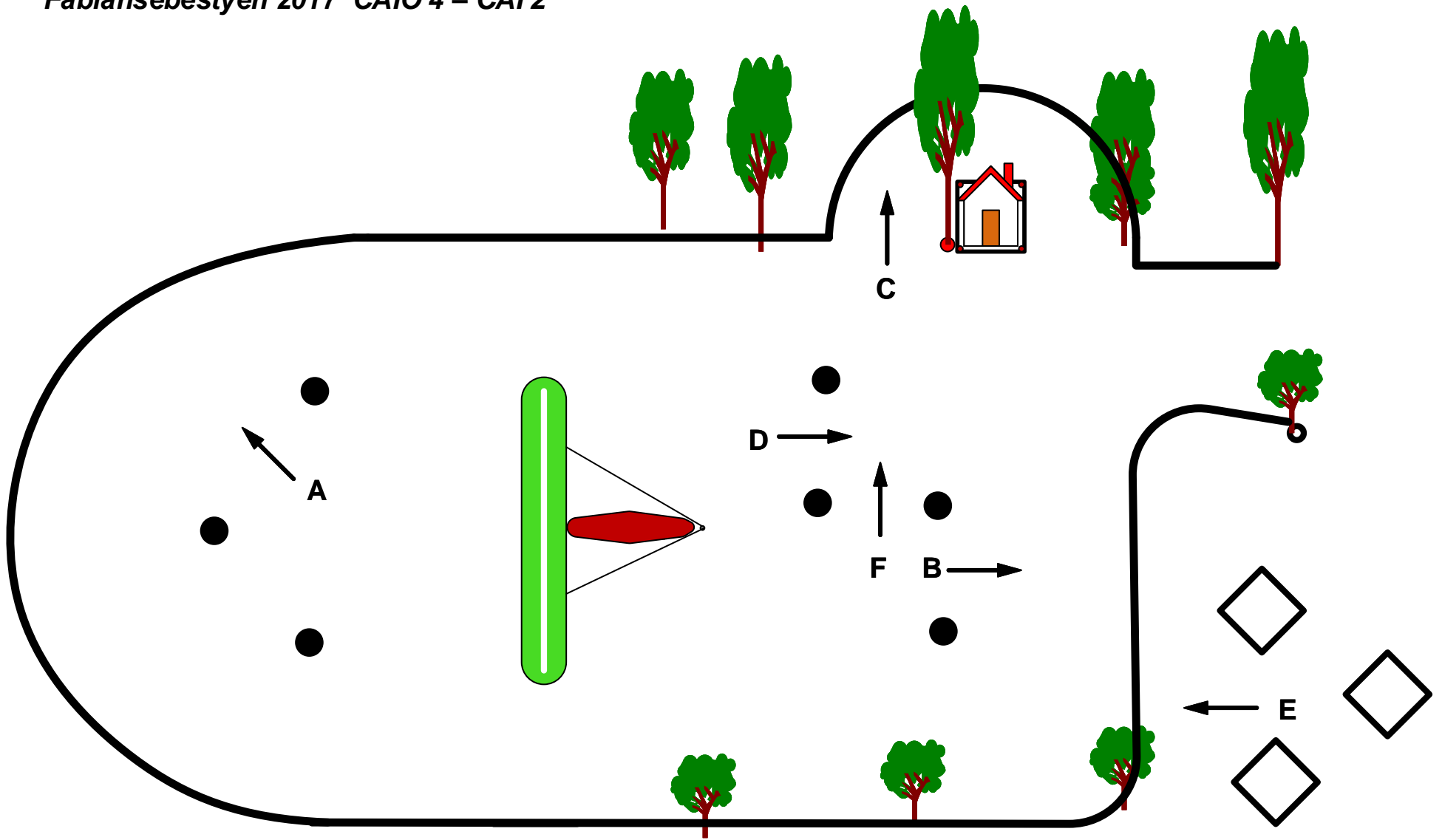

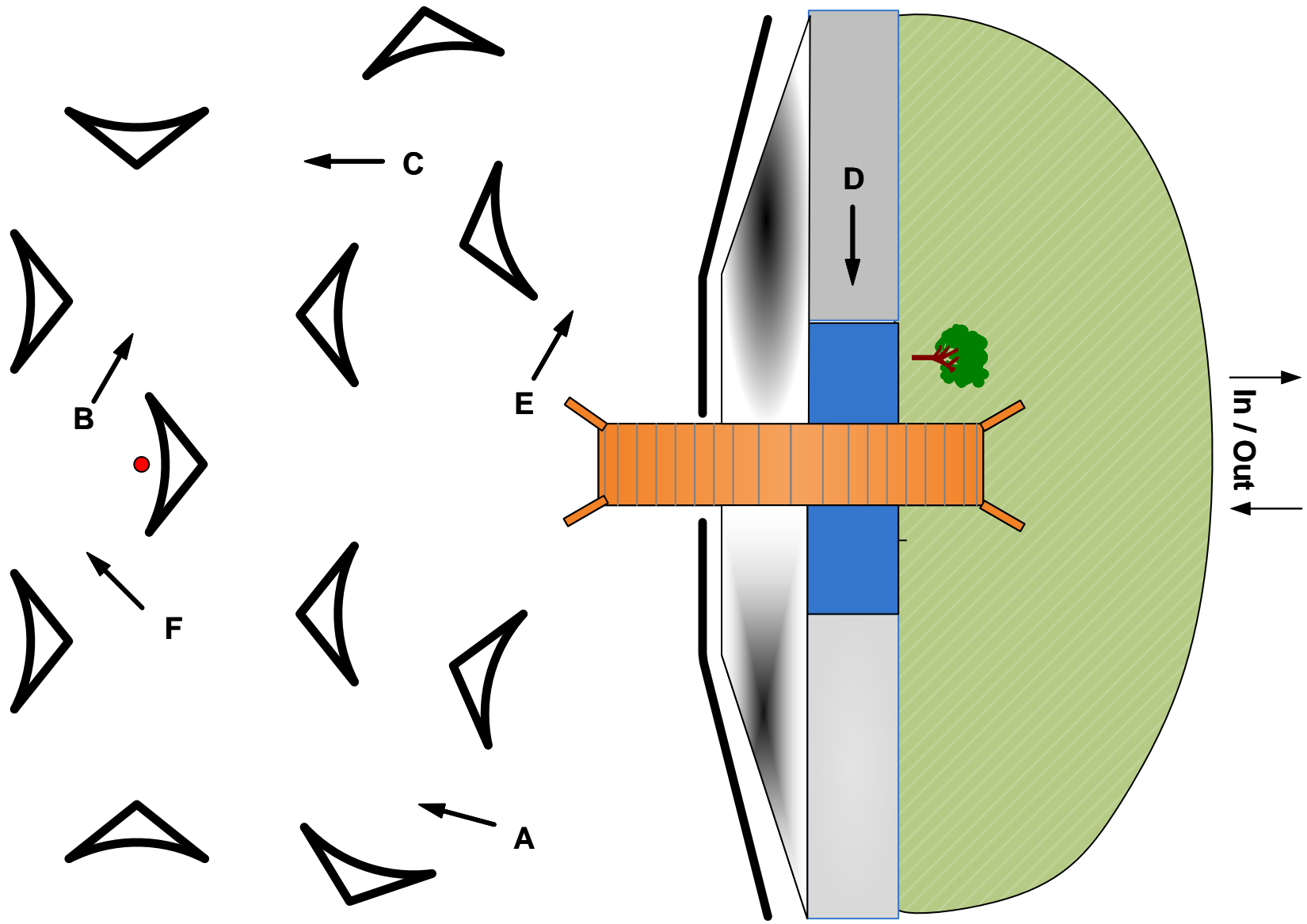

Knock down: 1

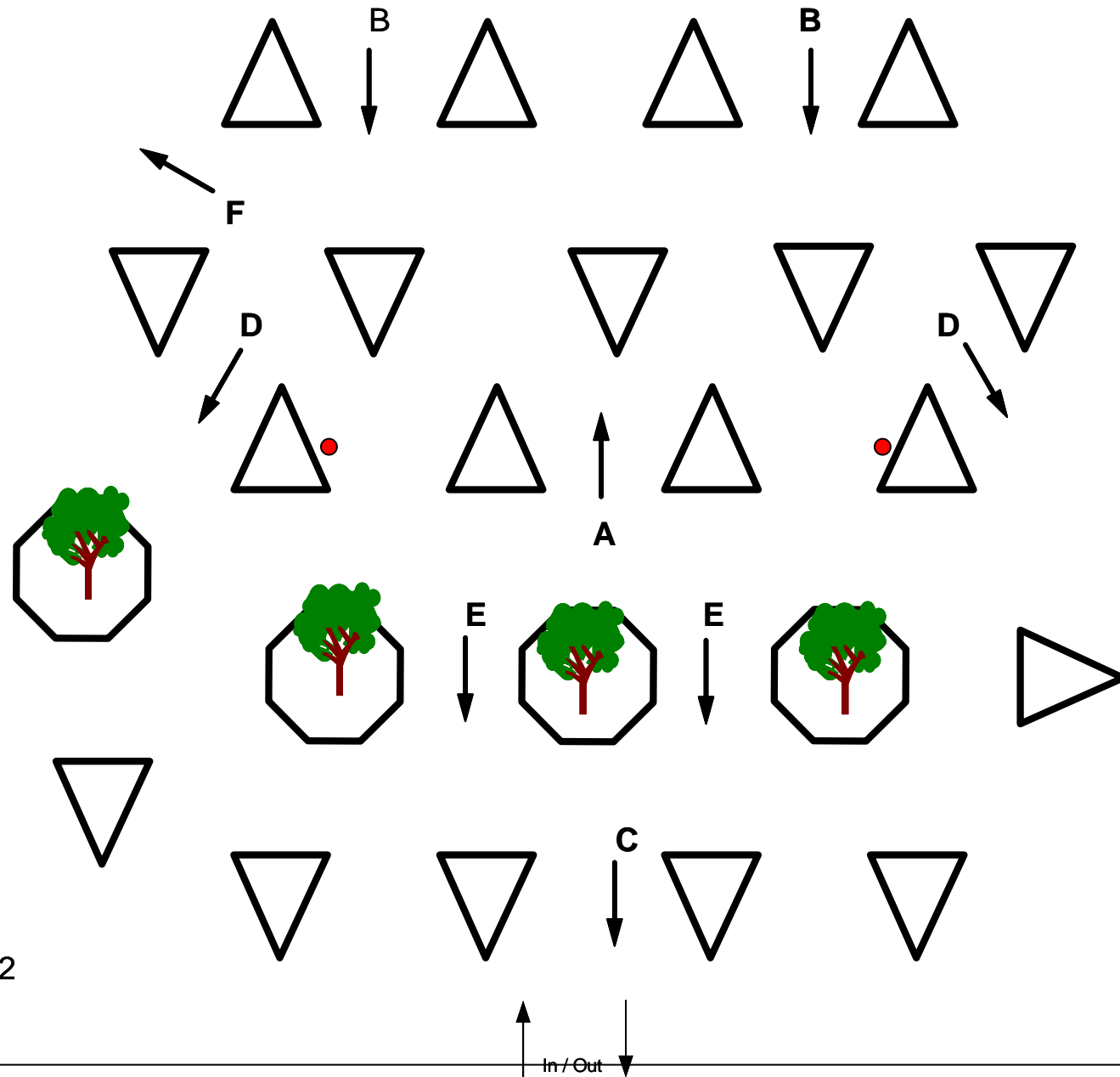

Knock down 2